

SERIES: CP50 | **DESCRIPTION:** PELTIER MODULE**FEATURES**

- arcTEC™ structure on select models
- solid state device
- precise temperature control
- quiet operation

**MODEL**

| | input voltage ¹ max [Vdc] | input current ² max [A] | internal resistance ³ typ [Ω±10%] | output Qmax ⁴ | | output ΔTmax ⁵ | |
|------------------------|---|---|---|-----------------------------|-----------------------------|------------------------------|------------------------------|
| | | | | T _n =27°C [W] | T _n =50°C [W] | T _h =27°C [°C] | T _h =50°C [°C] |
| CP50141 | 2.1 | 5.0 | 0.31 | 5.5 | 6.1 | 68 | 75 |
| CP50241 | 3.8 | 5.0 | 0.56 | 10.0 | 11.1 | 68 | 75 |
| CP50301541 | 4.2 | 5.0 | 0.63 | 11 | 12.3 | 68 | 75 |
| CP5030395 ⁶ | 11.8 | 5.0 | 1.74 | 35.0 | 38.0 | 70 | 77 |
| CP50341 ⁶ | 8.6 | 5.0 | 1.29 | 23.0 | 25.7 | 70 | 77 |
| CP50441 ⁶ | 15.4 | 5.0 | 2.3 | 41.0 | 45.8 | 70 | 77 |

Notes: 1. Maximum voltage at ΔT max and T_n=27°C
 2. Maximum current to achieve ΔT max
 3. Measured by AC 4-terminal method at 25°C
 4. Maximum heat absorbed at cold side occurs at I_{max}, V_{max}, and ΔT=0°C
 5. Maximum temperature difference occurs at I_{max}, V_{max}, and Q=0W (ΔT max measured in a vacuum at 1.3 Pa)
 6. Designed with arcTEC™ structure

SPECIFICATIONS

| parameter | conditions/description | min | typ | max | units |
|----------------------------|---|-----|-----|-----|-------|
| solder melting temperature | connection between thermoelectric pairs | 235 | | | °C |
| assembly compression | | | | 1 | MPa |
| RoHS | yes | | | | |

MECHANICAL DRAWING

units: mm

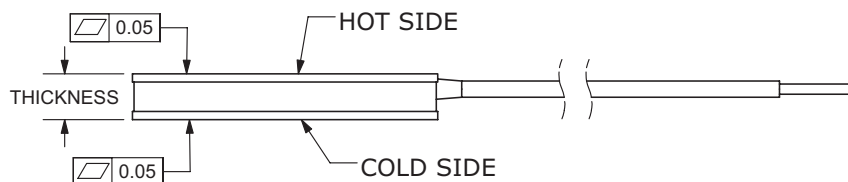

| | MATERIAL | PLATING |
|---------------|---|---------|
| ceramic plate | 96% AL ₂ O ₃ | |
| wire leads | 20 AWG | tin |
| sealer | silicon rubber 703 RTV (between cold and hot side plates) | |
| joint cover | silicon rubber 703 RTV | |
| marking | P/N & S/N printed on cold side surface | |

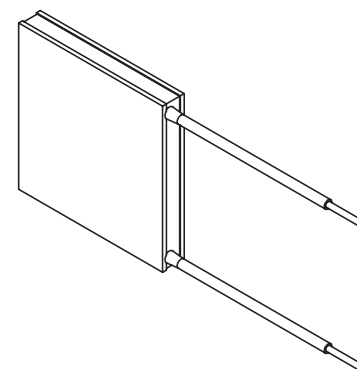
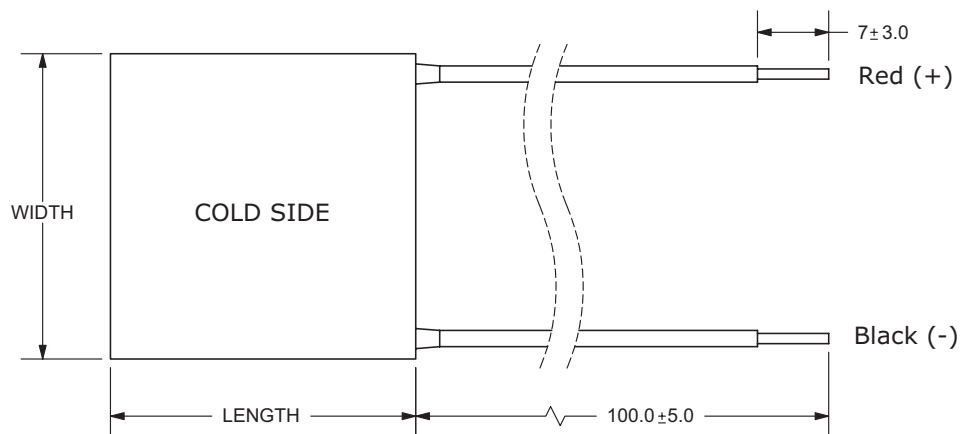

| MODEL NO. | LENGTH [mm] | WIDTH [mm] | THICKNESS [mm] |
|----------------------|-------------|------------|----------------|
| CP50141 | 15 ± 0.3 | 15 ± 0.3 | 4.0 ± 0.1 |
| CP50241 | 20 ± 0.3 | 20 ± 0.3 | 4.0 ± 0.1 |
| CP50301541 | 30 ± 0.3 | 15 ± 0.3 | 4.0 ± 0.1 |
| CP5030395 | 30 ± 0.3 | 30 ± 0.3 | 3.95 ± 0.025 |
| CP50341 ¹ | 30 ± 0.3 | 30 ± 0.3 | 4.0 ± 0.1 |
| CP50441 ¹ | 40 ± 0.3 | 40 ± 0.3 | 4.0 ± 0.1 |

Notes: 1. Wire lead strip length on models CP50341 & CP50441 is 10 ± 3.0 mm.

CP50141 PERFORMANCE (Th=27°C)

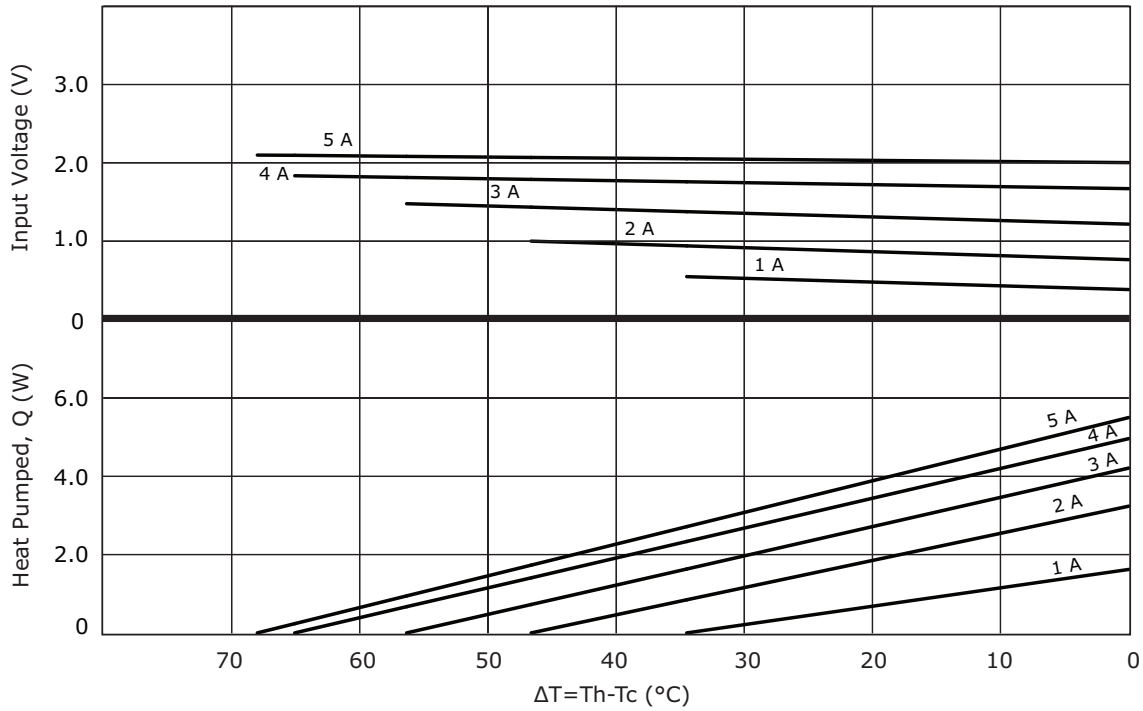

CP50141 PERFORMANCE (Th=50°C)

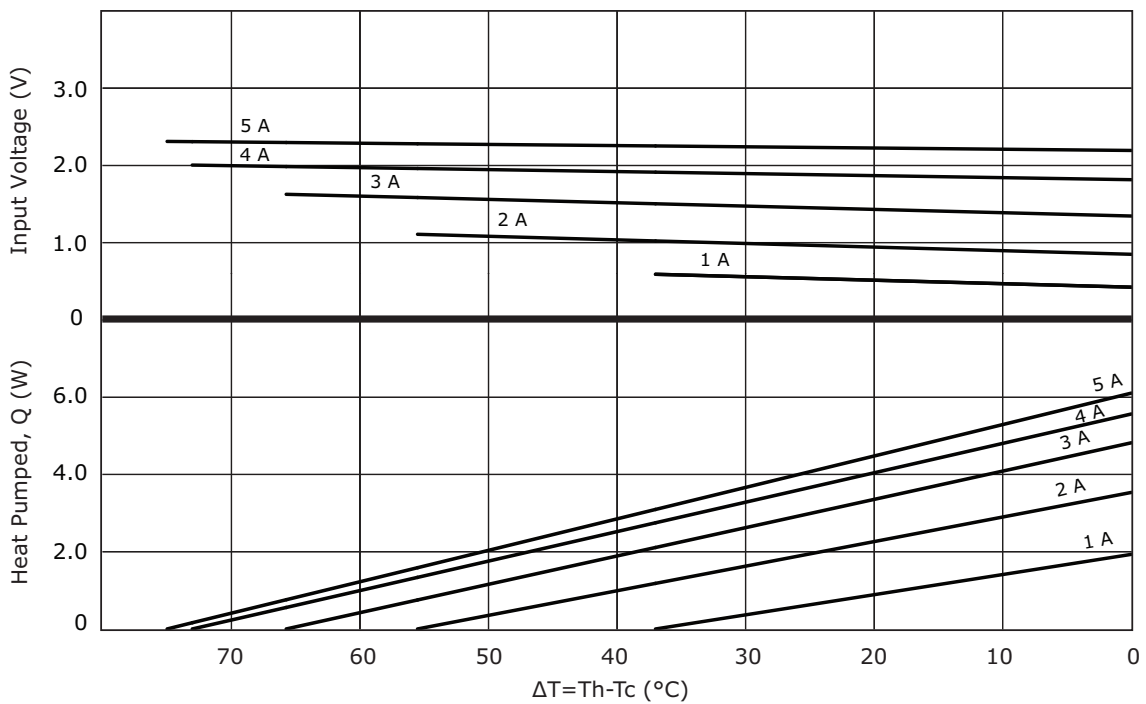

CP50241 PERFORMANCE (Th=27°C)

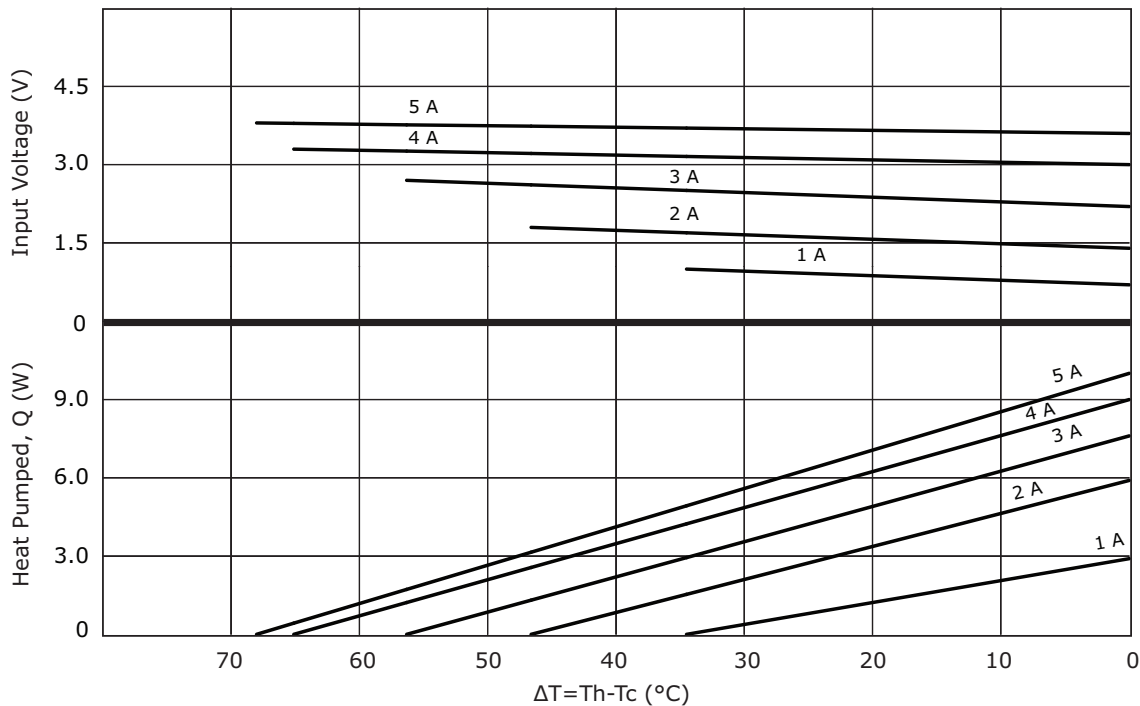

CP50241 PERFORMANCE (Th=50°C)

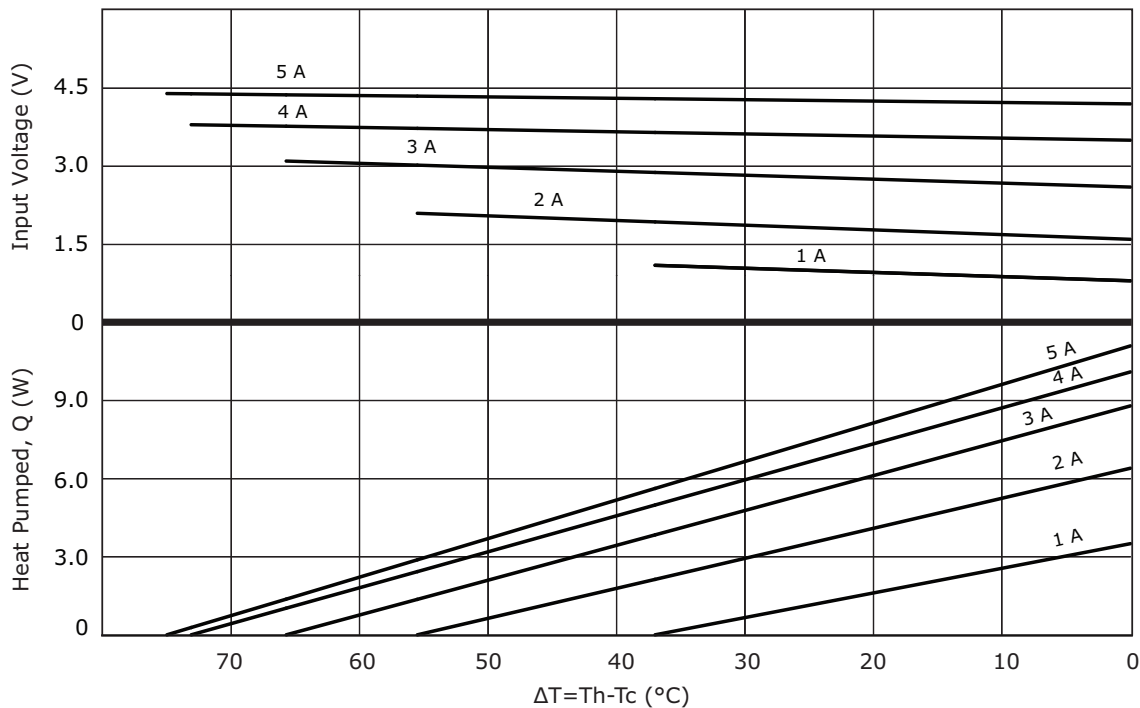

CP50301541 PERFORMANCE (Th=27°C)

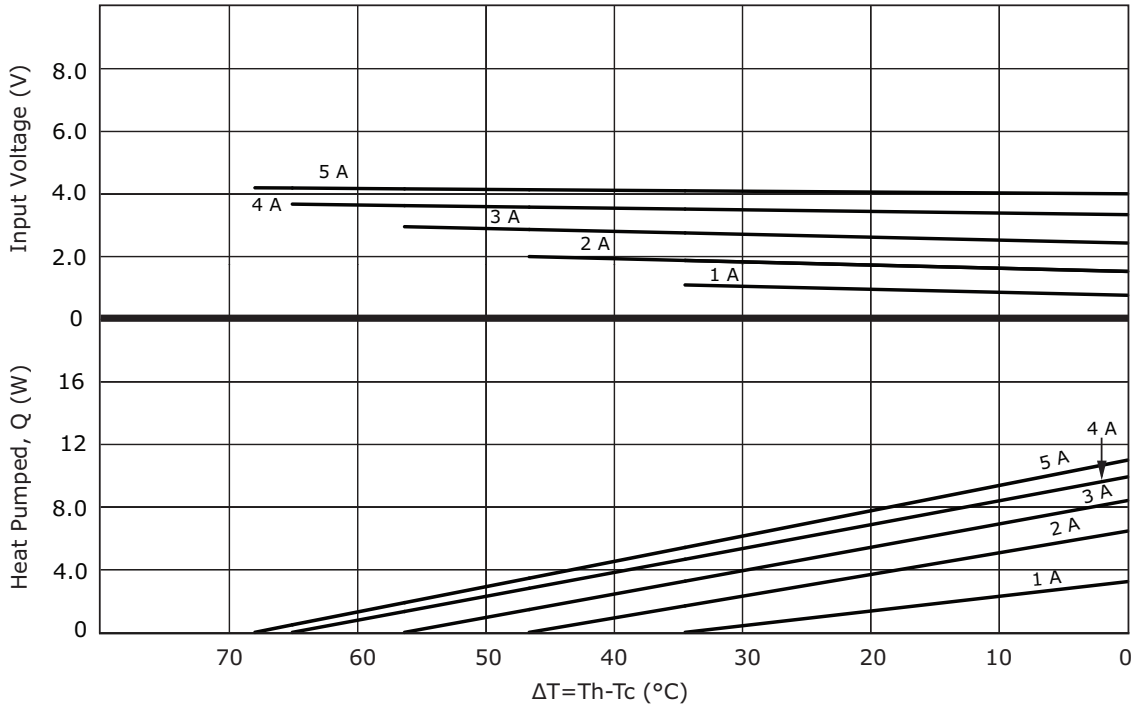

CP50301541 PERFORMANCE (Th=50°C)

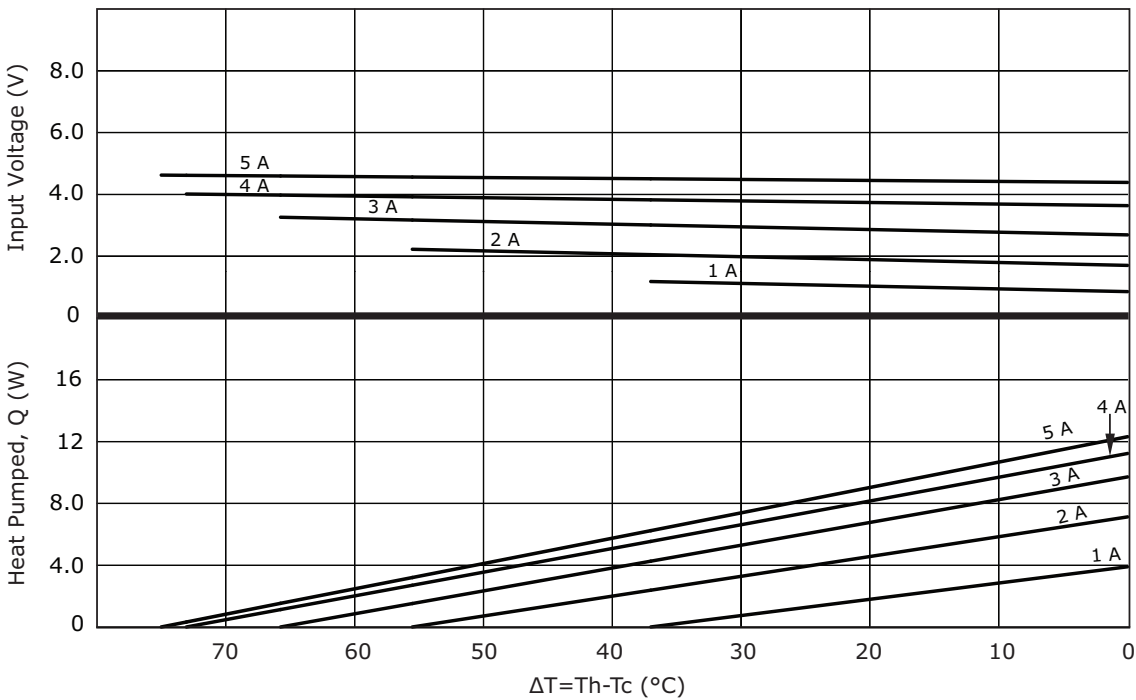

CP5030395 PERFORMANCE (Th=27°C)

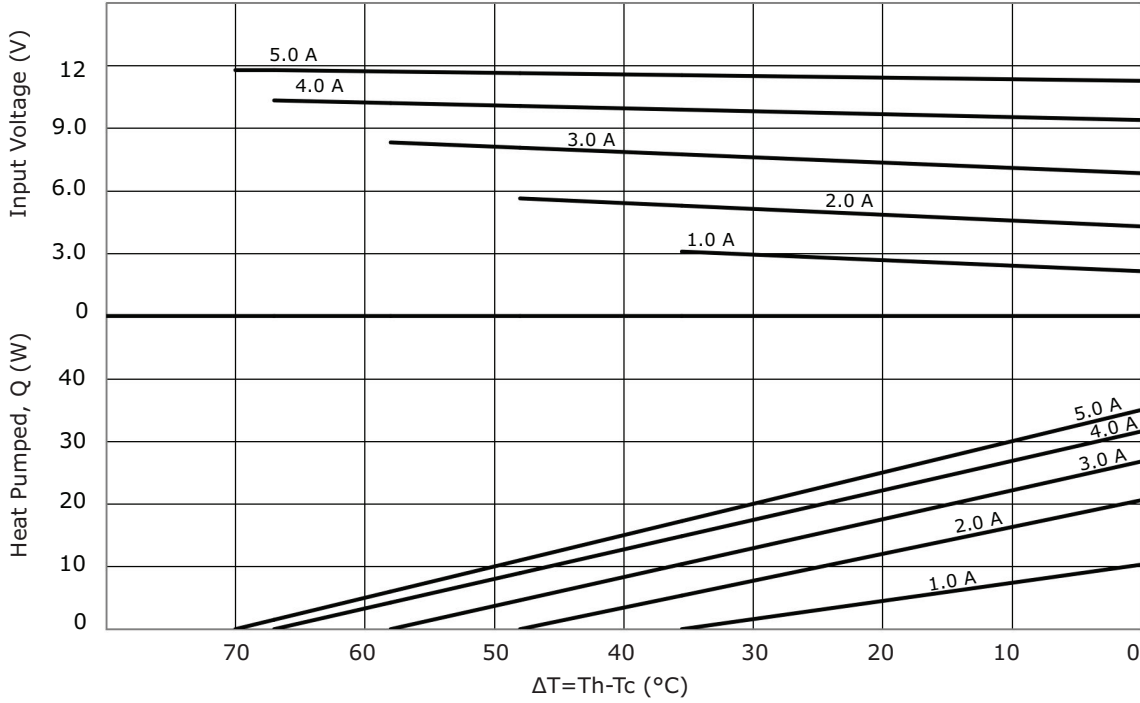

CP5030395 PERFORMANCE (Th=50°C)

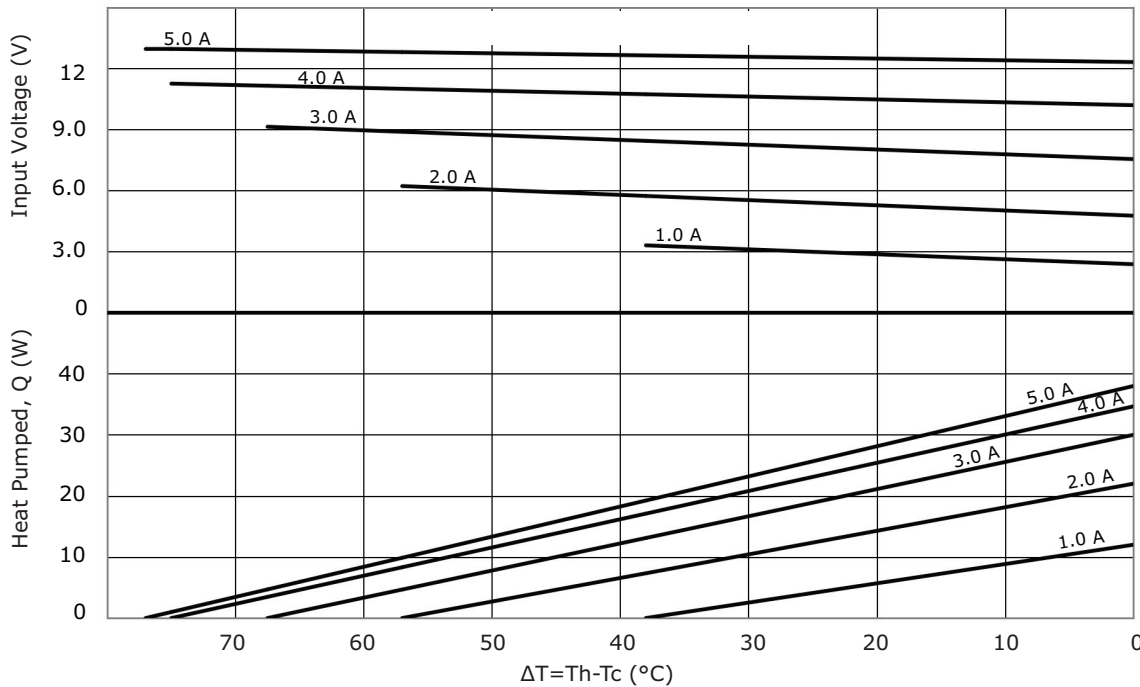

CP50341 PERFORMANCE (Th=27°C)

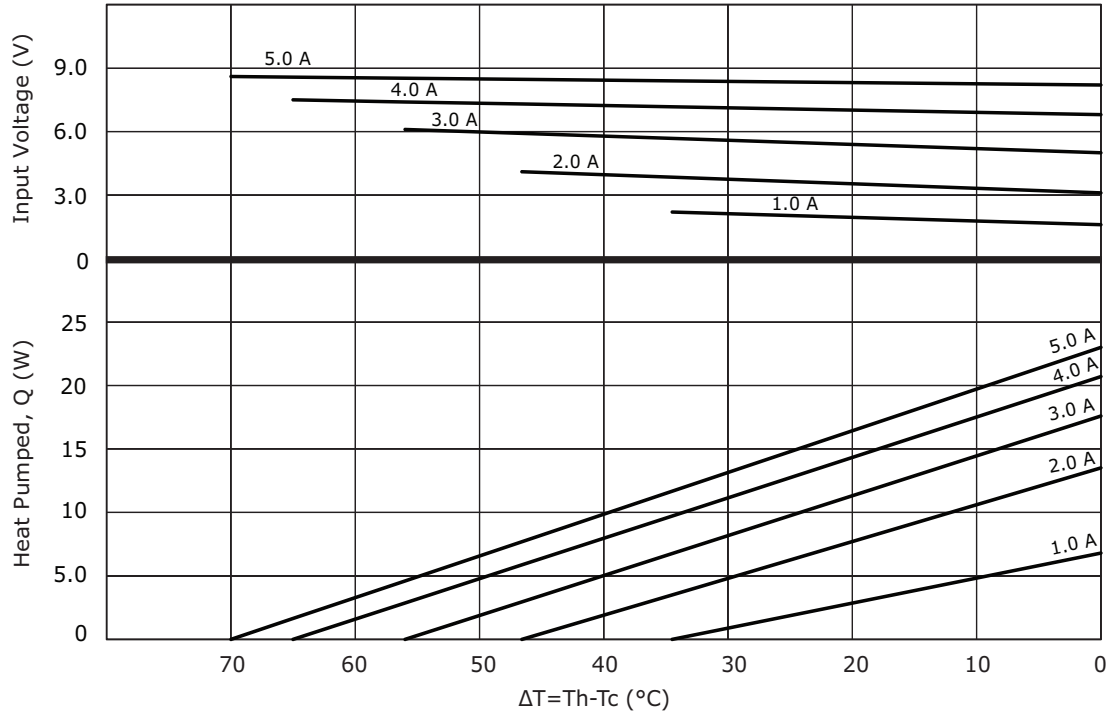

CP50341 PERFORMANCE (Th=50°C)



CP50441 PERFORMANCE (Th=27°C)

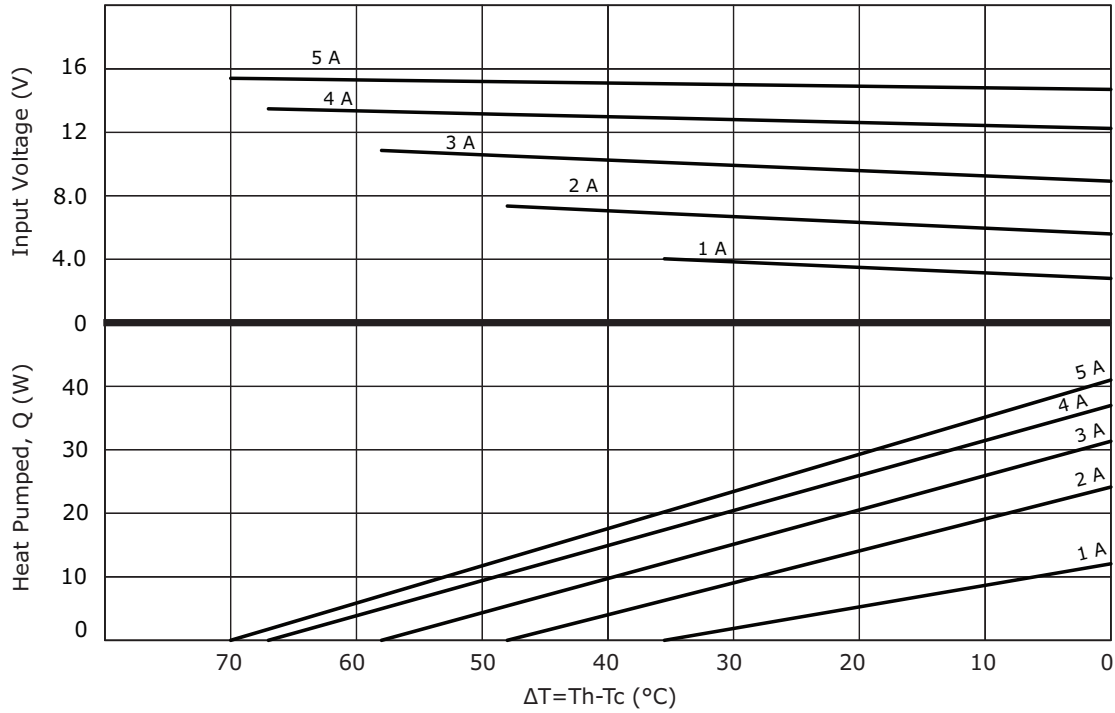

CP50441 PERFORMANCE (Th=50°C)

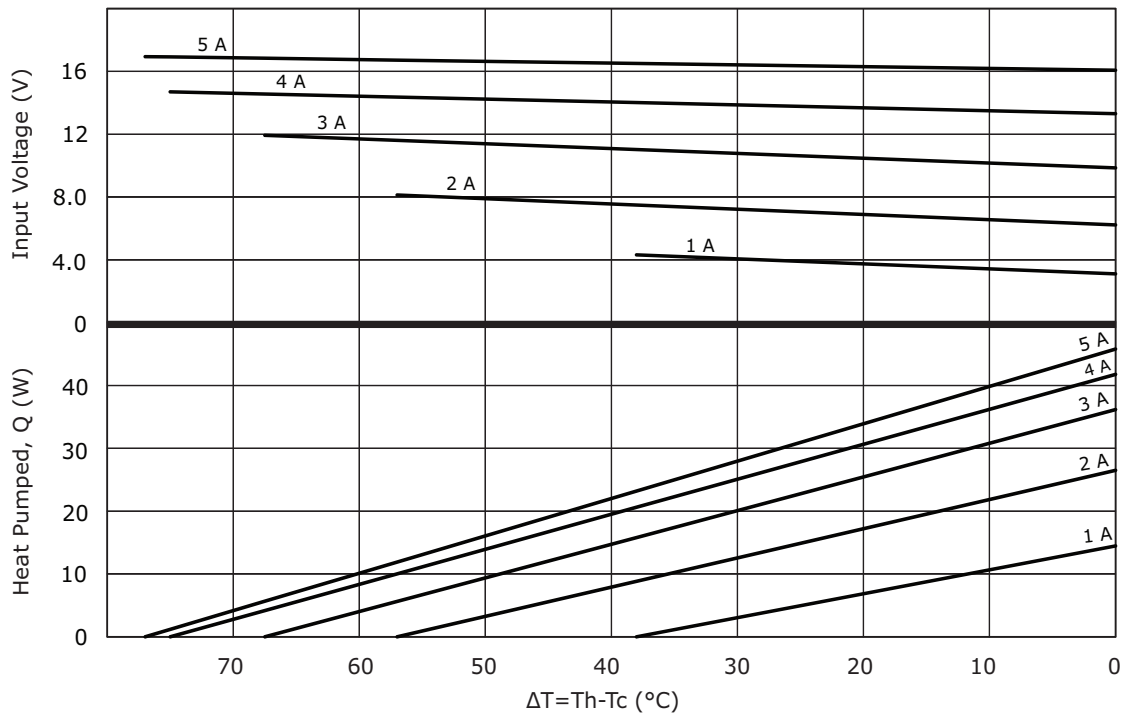

REVISION HISTORY

| rev. | description | date |
|------|--|------------|
| 1.0 | initial release | 09/08/2016 |
| 1.01 | changed models CP50341 & CP50441 to arcTEC™ structure | 12/01/2017 |
| 1.02 | changed thickness of CP50141, CP50241, CP50301541 models | 09/20/2018 |
| 1.03 | added model CP5030395, brand update | 10/18/2019 |
| 1.04 | logo, datasheet style update | 08/05/2022 |

The revision history provided is for informational purposes only and is believed to be accurate.



CUI Devices offers a one (1) year limited warranty. Complete warranty information is listed on our website.

CUI Devices reserves the right to make changes to the product at any time without notice. Information provided by CUI Devices is believed to be accurate and reliable. However, no responsibility is assumed by CUI Devices for its use, nor for any infringements of patents or other rights of third parties which may result from its use.

CUI Devices products are not authorized or warranted for use as critical components in equipment that requires an extremely high level of reliability. A critical component is any component of a life support device or system whose failure to perform can be reasonably expected to cause the failure of the life support device or system, or to affect its safety or effectiveness.

cuidevices.com